



Automation

NEW CAMOZZI SOLUTIONS



NEW CAMOZZI SOLUTIONS

Discover our latest components designed to meet the requirements of an ever more demanding market looking for innovation, reliability and higher flexibility.



Series MST

▶ Page 02

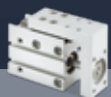

Series MSN

▶ Page 03



Series 5E

▶ Page 04



Series 3E

▶ Page 06



Series DRVI

▶ Page 07



Series KL-KLE

▶ Page 08



Series KDV-LDV

▶ Page 09



Series D

▶ Page 10



Series PME

▶ Page 15



**Series D
VA & VB
Versions**

▶ Page 12



Series PRE

▶ Page 14



Series BPA

▶ Page 16



**Series MX
Safemax with
soft start valve**

▶ Page 17



Series RTC

▶ Page 18



Series CGPL

▶ Page 19



Series GPM

▶ Page 19



Series GRIPfit

▶ Page 20

SECTORS AND APPLICATIONS



Industrial automation

Camozzi Automation offers a complete range of components, systems and technologies for industrial automation, including tailored solutions for any application.

APPLICATION AREAS:

Packaging, Food & Beverage, Plastics & Rubber, Automotive, Electronic Systems, Textile Machinery, Assembly & Robotics, Printing & Paper, Woodworking Machinery



Life Science

Camozzi Automation supports the Life Science sector with a wide range of components and customised solutions for the control of fluids - both liquids and gases - with high efficiency and high reliability performance.

APPLICATION AREAS:

Medical Devices, Biotechnologies



Transportation

Camozzi Automation offers the Transportation sector a wide range of solutions, ready for use in harshest conditions, assuring reliable and efficient operation - Every Day.

APPLICATION AREAS:

Truck & Trailer, Bus & Coach, Rail, Off Road, Passenger Car & Light Commercial Vehicles



SERIES MST: MAXIMUM FORCE AND PRECISION FOR ANY APPLICATION

Series MST pneumatic slides are the ideal solution for applications that require a **high level of force and extremely precise positioning** like in the assembly and packaging sector. The combination of a pneumatic cylinder with double piston and a precision roller guide allows for extremely accurate positioning, reducing positioning errors to a minimum, while **enhancing the overall efficiency of the system**. Series MST is available in six different sizes and standard strokes. It has been designed to satisfy the most specific application needs and with special accessories it is possible **to adjust the stroke length** in both positions; extended and retracted, increasing the flexibility and versatility of the product. Moreover, this series is compatible with magnetic switches for position detection, making it particularly suitable for applications that require quick and precise positioning. Its reliability and compact dimensions, make the Series MST the right choice **to optimise any system's performance, guaranteeing very precise and reliable results**.



BENEFITS



High stiffness and precision



Compact and light design



Adjustable stroke length



Hydraulic end stroke cushioning

MAIN TECHNICAL FEATURES

Sizes	6, 8, 12, 16, 20, 25 mm
Min-Max stroke	10 ÷ 150 mm

SERIES MSN: MAXIMUM PERFORMANCE WITH MAXIMUM PRECISION

Series MSN slides are an optimum solution **to control rapid and precise movements**, making them highly suited to the pick & place and inserting applications commonly found in the assembly and secondary packaging sectors. This series is available in four different sizes and provides a smooth and precise movement due to the combination of a pneumatic cylinder and a precision ball bearing guide. Series MSN slides provide **fast and precise handling**, ideal for applications that work with high load handling frequencies.

Furthermore, they are equipped with integrated proximity switches for position monitoring, in order to reach a high level of precision and to **maintain a constant position over time**. Their compact and light design allows the Series MSN slides to be used in confined spaces and in industrial applications in which a high flexibility of load handling is required.



BENEFITS



Compact and light design

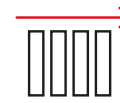

High positioning precision



Integrated rubber buffer

MAIN TECHNICAL FEATURES

Sizes	6, 10, 16, 20 mm
Min-Max stroke	5 ÷ 60 mm

SERIES 5E: THE ULTIMATE IN FLEXIBILITY AND EFFICIENCY

Series 5E axes are mechanical linear actuators in which the rotary movement generated by a motor is converted into a linear movement using a **toothed belt or a recirculating ball screw**. Series 5E, available in 3 sizes, 50, 65 and 80, is designed with a special self-supporting square profile with a recirculating ball guide integrated within the actuator, **providing exceptional stiffness and resistance to external loads**. The profile is covered by a stainless steel plate to protect the internal elements from environmental contaminants. The axis is equipped with a magnet that allows external proximity switches, enabling operations like homing or extra-stroke readings to be performed. These two versions make the Series 5E suitable to meet the needs of different industries, including **packaging, assembly and automotive**.

APPLICATIONS

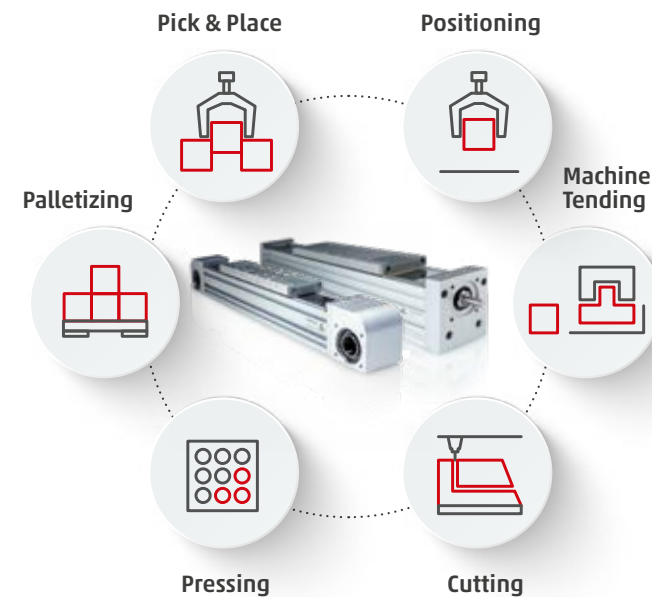

MODULAR DESIGN

Utilising a modular design, the Series 5E can be combined to create multi-axis solutions with different transmission technologies to guarantee maximum flexibility and adaptability for the customer.

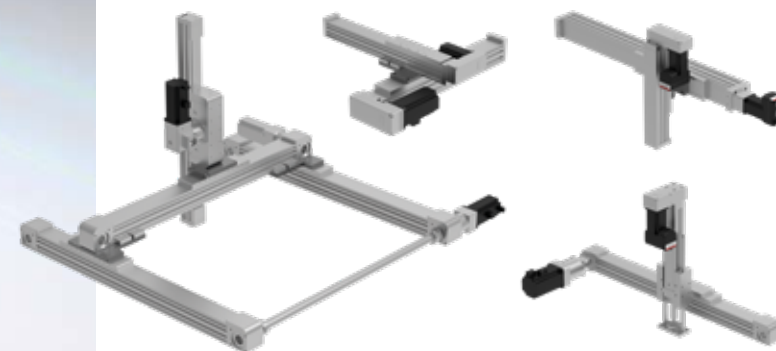

DESIGNED FOR ANY APPLICATION

Series 5ES...TBL



Multi-position system with movement transmission via a toothed belt.



Suitable for high dynamics



Suitable for high speeds

MAIN TECHNICAL FEATURES

Sizes	50, 65, 80
Protection class	IP40
Max stroke	6 m
Max speed	5 m/s

Series 5ES...BS



Multi-position system with movement transmission via ball screw.



High accuracy and repeatability



High payload capacity

MAIN TECHNICAL FEATURES

Sizes	50, 65, 80
Protection class	IP40
Repeatability	± 0,02 mm
Max force	4000 N

SERIES 3E: QUICK, FLEXIBLE AND EASY TO USE

Series 3E cylinders are electric rod actuators that combine a screw and motor to generate **accurate linear motion**. These are an alternative to pneumatic cylinders but possessing all the benefits of electric actuators in terms of speed, ease of parameter setting and flexibility in handling different load sizes and formats. Their compact design ensures easy integration with the machine, without affecting performance. **Robust and quick**, these actuators are ideal for multi-position applications and can be used with external proximity switches for homing operations or allowing extra-stroke readings to be performed. Moreover, Series 3E can be supplied **with the motor already assembled**, to further reduce commissioning and wiring time. Series 3E compact electromechanical cylinders are the ideal solution for industrial applications that require rapid format changeovers or numerous production cycles. Their precision, reliability and flexibility, make these cylinders ideal for use in assembly lines, packaging systems or for material handling.



BENEFITS



Flexible and easy to use



Reduced commissioning times



Increased machine efficiency and productivity

MAIN TECHNICAL FEATURES

Sizes	20, 32
Screw pitch	3 - 10
Max force	up to 1000 N
Max speed	up to 1,3 m/s
Max stroke	up to 500 mm

SERIES DRVI: A PRECISE, FAST AND VERSATILE DRIVE

The Series DRVI integrated motor drive is designed **to control various types of motors**, both stepper and brushless, using a closed-loop control (FOC) algorithm. This algorithm, also known as vector control (FOC), offers **better performance than traditional stepper motor control systems**, which allows the stepper motor to operate over the entire speed range, ensuring fast acceleration and deceleration, assuring more accurate motion control with no loss of steps.

It is also more energy efficient than traditional control methods, as it uses precise rotor position feedback and controls the phase current, optimising motor operation. Its **compact design** and integration with the main communication protocols make the Series DRVI the **ideal solution for various industrial applications** that require accurate control and fast response to load variations.



BENEFITS

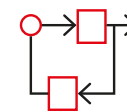

Integrated solution
Encoder, motor, and drive
all in one



Flexibility
Different types of operating
modes: position, speed and torque



Energy efficient
Compared to traditional
stepper motors



Precise Positioning
With no loss of steps achieved
through Field-Oriented Control



**Different
communication protocols**
CANopen - Profinet - EtherCAT -
Ethernet IP

MAIN TECHNICAL FEATURES

Flange size	NEMA 23 and 24
Motor type	Stepper and DC Brushless
Max speed	up to 3000 rpm
Torque	1.2 Nm - 2.2. Nm

SERIES KL-KLE: HIGH FLOW RATES IN A COMPACT DESIGN

The latest Series KL and KLE **miniaturised 10 mm solenoid valves** have been designed for industrial applications and medical devices that require high flow rates and pressures within compact dimensions. Its **compact design, reduced weight and low energy consumption** makes the KL version the ideal solution for applications within confined spaces and limited power supply, such as portable oxygen concentrators or emergency lung ventilators. For applications that demand more robust levels of performance, the KLE version has been designed to control higher pressures and flow rates compared to traditional solenoid valves. The body size and overall dimensions of both versions have been designed to allow **easy integration with manifold systems or subbases** and to be quickly installed on devices and machines. Series KL and KLE are available in different models to satisfy any application across all the main sectors of **industrial automation and life science**.



BENEFITS



Reduced installation times

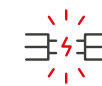

Easy and flexible to install in the system



Energy efficient



High reliability



Components compliant with medical devices



Compact design and reduced weight for portable devices

MAIN TECHNICAL FEATURES

Size	10 mm
Function	2/2 NC-NO, 3/2 NC-NO-UNI
Orifice diameter	0.6 ... 1.6 mm

SERIES KDV-LDV: HIGH CHEMICAL RESISTANCE IN CONTACT WITH FLUIDS

The media-separating solenoid valves Series KDV and LDV are designed to **control critical fluids such as aggressive, high-purity or temperature-sensitive fluids**. To prevent the controlled fluid from interacting with the internal mechanical part of the valve, the orifices are opened or closed using a separating diaphragm, driven by an actuator. In addition to protecting the **controlled fluid from contamination or excessive temperature fluctuations**, the diaphragm protects the actuator system from any possible corrosion caused by aggressive fluids. Its compact design, light weight and low power consumption make the Series KDV (10mm), the ideal solution for applications within confined spaces and limited power supply. For applications that demand more robust levels of performance, the LDV version (15mm) has been designed to **control higher pressures and flow rates compared to traditional solenoid valves**. The media separated solenoid valves Series KDV and LDV are ideal for the Life Science applications that require precision and reliability, such as mass spectrometry, liquid and gas chromatography and molecular analysis.



BENEFITS



Suitable for aggressive, high-purity or temperature-sensitive fluids



Compact design and light weight for portable devices



Easy and quick assembly



High reliability



Energy efficient

MAIN TECHNICAL FEATURES

Size	10 mm, 15 mm
Function	2/2 NC-NO, 3/2 NC-NO-UNI
Orifice diameter	0.8 ... 1.6 mm

SERIES D: MODULAR AND FLEXIBLE

Series D is a new valve system that ensures **maximum flexibility and productivity** across many primary industrial automation processes. Single pneumatic and electric subbases plus a **simple valve-connection system** make the Series D valve island the ideal solution for all applications that require quick and **easy installation** of pneumatic functionality. Series D is available in both multipole and in serial communication versions. The Fieldbus module allows control of the valve island using the main fieldbus protocols, making it **easy to integrate pneumatic and electrical functionality** in the most advanced automation systems.

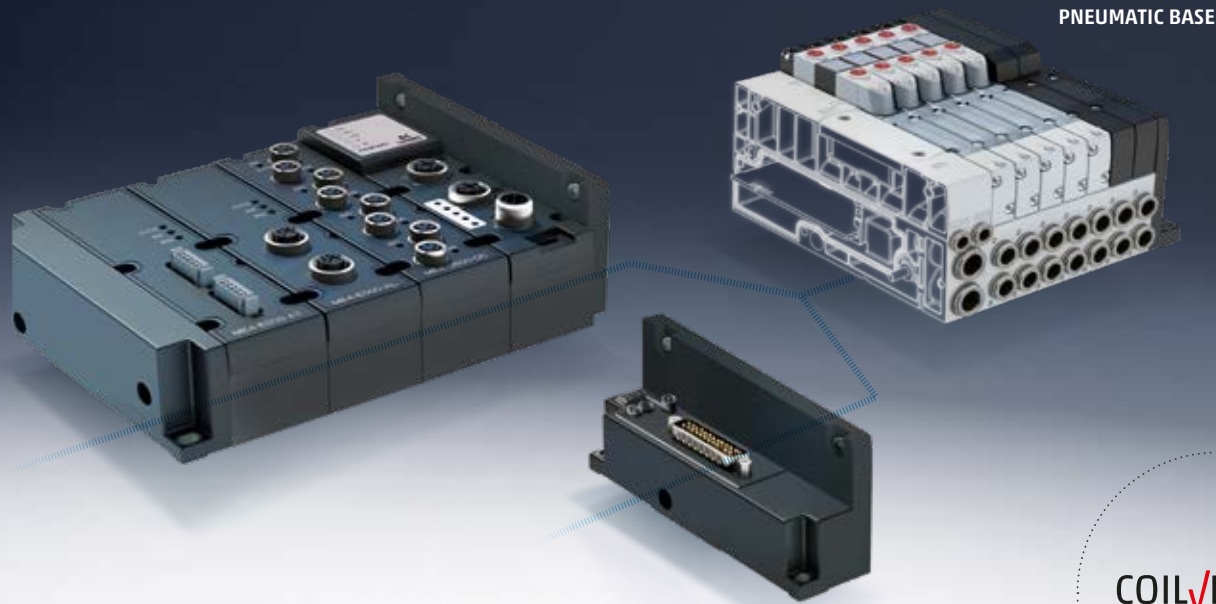

FIELDBUS VERSION

128 Digital I/O and 16 Analog I/O
with up to 128 coils on 64 valve positions

IO-LINK VERSION

64 coils on 32 valve positions

MULTIPOLE MODULE

Sub-D 25 pins with up to 11 valve positions
Sub-D 44 pins with up to 19 valve positions

PNEUMATIC BASE

COILVISION®
TECHNOLOGY

BENEFITS

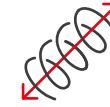

Flexibility in connecting
different I/O modules



Integrated diagnostics
and predictivity



Available protocols:
**PROFIBUS-DP, CANopen,
EtherNet/IP, PROFINET,
EtherCAT, IO-Link**



UL Recognized Components
for Canada and
the United States

The Series D valve island is also equipped with **CoilVision® technology** which can monitor and predict the wear and efficiency status of selected parts of the solenoid valves. The gathered data, alarm history and health status are indicated through different combinations of flashing LEDs on the module and can be sent to a PLC or to a wireless IIoT gateway and then on to the Cloud.

4 SIZES FOR UNLIMITED APPLICATIONS

Series D - Size 1



The ideal solution for all industrial applications that require quick and easy installation of pneumatic functionality in restricted spaces.

MAIN TECHNICAL FEATURES

Size	10.5 mm
Flow	250 NI/min



Compact design

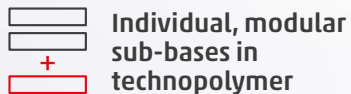

Individual, modular sub-bases in technopolymer

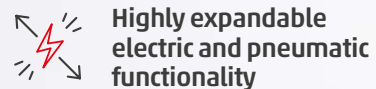

Highly expandable electric and pneumatic functionality

Series D - Size 2



Designed for applications that demand compact dimensions and high flow rates.

MAIN TECHNICAL FEATURES

Size	16 mm
Flow	950 NI/min



Compact design

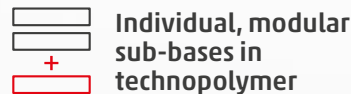

Individual, modular sub-bases in technopolymer

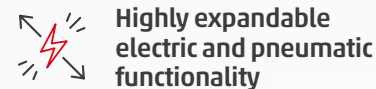

Highly expandable electric and pneumatic functionality

Series D - Size 4



Particularly suitable for all applications that require high flow rates and require solutions with a robust and compact design.

MAIN TECHNICAL FEATURES

Size	25 mm
Flow	2000 NI/min



High flow rates

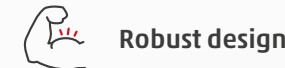

Robust design

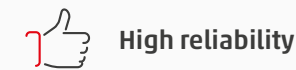

High reliability

Series D - Size 5



A single island with a mix of sizes (10.5 and 16) that offers one Multipole or Fieldbus connection, with common positional fixings and single modularity.

MAIN TECHNICAL FEATURES

Size	10.5 + 16 mm
Flow	250 - 950 NI/min

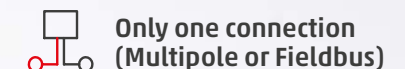

Only one connection (Multipole or Fieldbus)

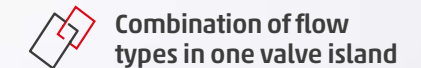

Combination of flow types in one valve island

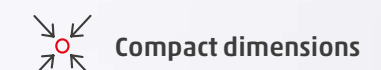

Compact dimensions

SERIES D - VA and VB Versions: VERSATILE, COMPACT, FLEXIBLE

Series D range is enhanced with the addition of two new valve and solenoid valve variants that are easy to install and deliver **high performance within a compact footprint**.

The VA and VB versions are available in three sizes with different flow rates. They can both be **used individually or mounted to a manifold**. Thanks to their versatility, compact design and aluminium body, the Series D valves and solenoid valves are suitable for a wide range of industrial applications, from traditional uses right through to more innovative or demanding sectors. The valves' functionality and high flexibility make them an extremely **versatile and precise solution** to meet every need.

BENEFITS



Robust design



Compact design for restricted spaces

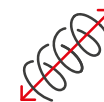

Maximum versatility



CONNECTOR PORTS
ON VALVE BODY

SUBBASE WITH UP TO 19
VALVE POSITIONS

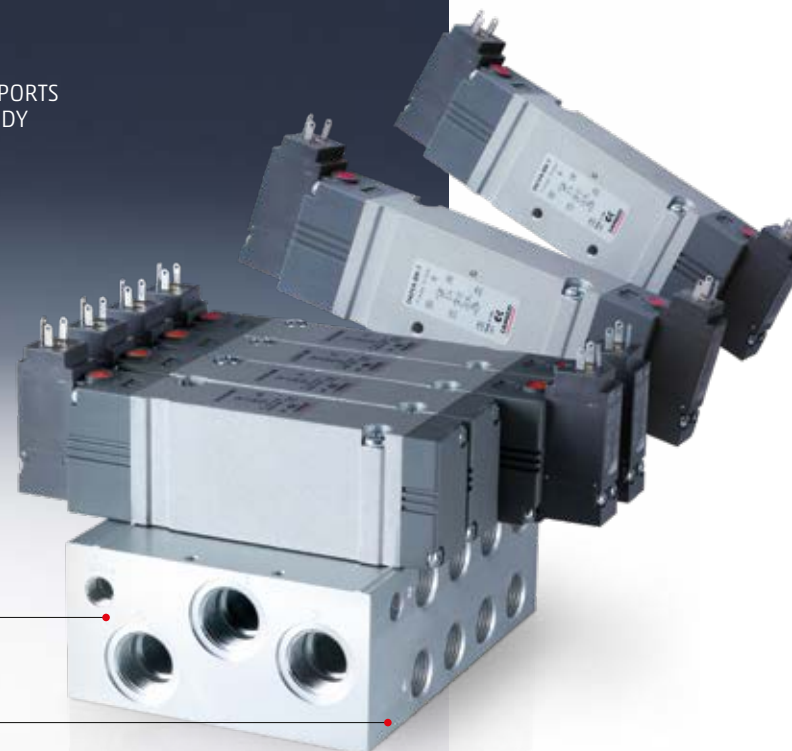

SUBBASE WITH UP TO 19
VALVE POSITIONS

CONNECTOR PORTS
ON SUBBASE

VA and VB Versions

Series D - VA Version



MAIN TECHNICAL FEATURES

Pneumatic connection (VA version)

Connector ports on valve body

Allows manifold mounting

Series D - VA and VB Versions



MAIN TECHNICAL FEATURES

Electrical connection (VA and VB versions)

<i>Micro connector</i>	size 10.5, 16 mm
------------------------	-------------------------

<i>M8 connector</i>	size 10.5, 16 mm
---------------------	-------------------------

<i>EN 175301C connector</i>	size 16, 25 mm
-----------------------------	-----------------------

SERIES PRE: DIGITAL PRESSURE MANAGEMENT

The Series PRE proportional pressure regulator is equipped with **CoilVision® technology** which constantly **monitors the operation of the solenoids** in the regulator to assess their health status. All data generated by the regulator can be transmitted wirelessly, for logging, aggregation and analysis and can be viewed through the **UVIX software**, downloadable from the Camozzi Catalogue website. The Series PRE is available in two sizes and in different configurations, including **IO-Link connectivity**. As well as the standard options with and without display, there is a version with an integral exhaust valve, which enables the system to exhaust even without a power supply. A **manifold version** enables the control of several outlets with only one inlet, while a version with an additional external sensor connection enables **pressure control at any point in the system**.



AVAILABLE VERSIONS

- IO-Link version
- 
- Manifold version
- Version with integrated exhaust valve

BENEFITS



Integrated diagnostics and predictivity



Compatible with OXYGEN



Configuration flexibility



UL Recognized Components for Canada and the United States



Easy integration with Series MD FRL Units

MAIN TECHNICAL FEATURES

Flow (Qn)	PRE104 - 1100 NL/min PRE238 - 4600 NL/min
Pneumatic ports	G1/4 - G1/8 - G3/8 - 1/4 NPTF

SERIES PME: COMPACT, LIGHT AND WITHOUT COMPROMISE

The Series PME proportional pressure regulator is the ideal solution for industrial applications that require **accurate pressure control**. This new pressure regulator offers a high pneumatic performance, despite having its weight and dimensions reduced to a minimum to allow **greater flexibility in its use**. Series PME is available in two sizes and versions. **One version has an integrated exhaust valve that allows the system to discharge even in the absence of power. The second is a manifold version, ideal for controlling several outlets with only a single air inlet. A new CANopen serial version is also available. Ideal for controlling multiple controllers on a single fieldbus and for applications that need to operate within a wide supply voltage range (12÷24 V DC).**



BENEFITS

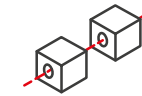

Manifold version

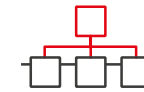

CANopen version



Integrated exhaust valve version



Easy integration with Series MD FRL Units



Compact and essential



Configuration App that uses NFC technology

MAIN TECHNICAL FEATURES

Flow (Q_n)	PME104 - 1100 NL/min PME238 - 4600 NL/m
Pneumatic ports	G1/4 - G1/8 - G3/8 - 1/4 NPTF

CANopen

READY

SERIES BPA: EXTRA PRESSURE. PRECISELY APPLIED.

This pressure booster, with ratio of 1:2, increases outlet pressure by up to 20 bar. It operates automatically when needed to generate a constant pressure increase while its mechanical design guarantees **quick and easy installation**, **minimises heat generation and improves machine safety**. Two versions are available, with or without an integrated regulator that allows to adjust the desired outlet pressure and enables the **efficient management of energy consumption**. It offers a compact, functional design with rapid filling times that makes the Series BPA ideal for applications where **high pressure is only needed at specific points in the pneumatic circuit** such as woodworking, marble and glass processing or with testing and assembly machines.



BENEFITS



Easy and flexible installation



Focused pressure increase

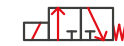

Optimisation of the pneumatic circuit



Energy efficient

MAIN TECHNICAL FEATURES

	BPA-040	BPA-063	BPA-100
Multiplication Ratio	2	2	2
Inlet pressure	2-10 bar	2-8 bar	2-8 bar
Flow rate (Pin = Pout = 5 bar)	250 l/min ANR	1000 l/min ANR	1500 l/min ANR

SERIES MX SAFEMAX WITH SOFT START VALVE: SAFETY AT YOUR FINGERTIPS

The new Series MX SAFEMAX soft start valve enables **gradual pressurisation of the system, while maintaining all safety functions**. The compact dimensions and the internal construction of the components allows **easy integration of the soft start valve with Series MX2** air treatment units without the need for additional connection interfaces.

The soft start valve is positioned upstream of the safety valves, so does not interfere with the exhaust air flow and allows the safety valves to **quickly discharge the system in the event of an emergency**.



BENEFITS



Compliant with Machinery Directive 2006/42/EC



Easy integration with Series MX2 FRL Units



Solutions to achieve up to Performance Level E

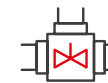

Integrated soft start valve



No connection interfaces needed

MAIN TECHNICAL FEATURES

Performance level (PL)	
Single version	category 2, PLd
Double version	category 4, PLe

SERIES RTC: MAXIMUM PRODUCTIVITY WITH MAXIMUM PRECISION

The Series RTC Tool Changer is the ideal solution for industrial applications that require an efficient and reliable device for a **fast and secure changeover of tools** (gripping or working systems). Series RTC is available in three sizes; 50, 90 and 150 and offers high reliability and robustness, handling loads of up to 50kg, and guaranteeing excellent performance even under very demanding operating conditions. Thanks to its compact design, the Tool Changer can be **easily integrated within industrial robots and cobots**, improving the efficiency and productivity of production lines on the one hand while providing enhanced flexibility and quality of work on the other. Using a special pneumatically operated accessory, the Tool Changer automates the opening and closing of the locking system, eliminating the need for this to be done manually by an operator. This makes the tool changing process faster and more accurate, **reducing human error to a minimum and guaranteeing a more reliable system.**



BENEFITS



Constant monitoring of the locking device status



Enhanced efficiency and accuracy



High load capacity



Reduction of downtime

MAIN TECHNICAL FEATURES

Sizes	50, 90, 150
Pneumatic connections	4, 8, 10

SERIES CGPL: FAST, FLEXIBLE AND EFFICIENT HANDLING

The long-stroke Series CGPL parallel gripper is a flexible and efficient solution for applications with restricted space. The integrated ball bearing guide and compact, lightweight design allow **fast and precise handling of components**, even in high-duty cycle situations. With its flat construction, this parallel gripper can **withstand high loads and rapid acceleration**, making it an ideal solution for assembly and industrial robotics.



MAIN TECHNICAL FEATURES

Size	8, 12, 16, 20
Total force	45 ÷ 340 N
Total stroke	8 ÷ 80 mm
Version	Double acting



Compact Design and Lightweight



Long stroke



High speed opening & closing



High repeatability

SERIES CGPM: ACCURATE, LIGHT AND RESILIENT

Our self-centering, parallel grippers with an H-shaped guide are available in 5 sizes with standard or long stroke. Its **compact size, high repeatability and rapid opening and closing speeds** make these pneumatic grippers particularly suitable for applications like Pick & Place, insertion of small objects and machine tending on automated processes with high or long production cycles.



MAIN TECHNICAL FEATURES

Size	12, 16, 25, 35, 45
Total force	28 ÷ 1082 N
Total stroke	5,3 ÷ 41 mm
Version	Single and double acting



Robust, compact and light design



High closing/opening repeatability



Protected from penetration by impurities

GRIPfit[®] : THE LATEST GENERATION OF PUSH-IN FITTINGS

The GRIPfit is the **latest generation of push-in fittings** developed to cover and satisfy the needs of various market applications: from industrial automation to life Science, from water treatment and beverages up to fluidic systems and power packs. Made with high-performance materials, this new range of fittings is equipped with a **flexible stainless steel gripping ring** to facilitate the connection and disconnection of most semi-rigid tubes, limiting the effects of tube marking and **guaranteeing a robust and reliable tightening** on the whole surface of the tube. GripFit is ideal for vacuum and low pressures both in static and dynamic applications, thanks to the **new shaped sealing technology**. The materials used comply with the main standards and directives and have been designed to meet and adapt perfectly to the specific application requirements of each sector. Reliable connection, compact dimensions and easy installation in confined spaces are only some of the features that make this new range of fittings an **innovative solution for many applications**.

FAST CONNECTION AND DISCONNECTION

FULL FLOW
Designed for optimal fluid flow to provide better efficiency

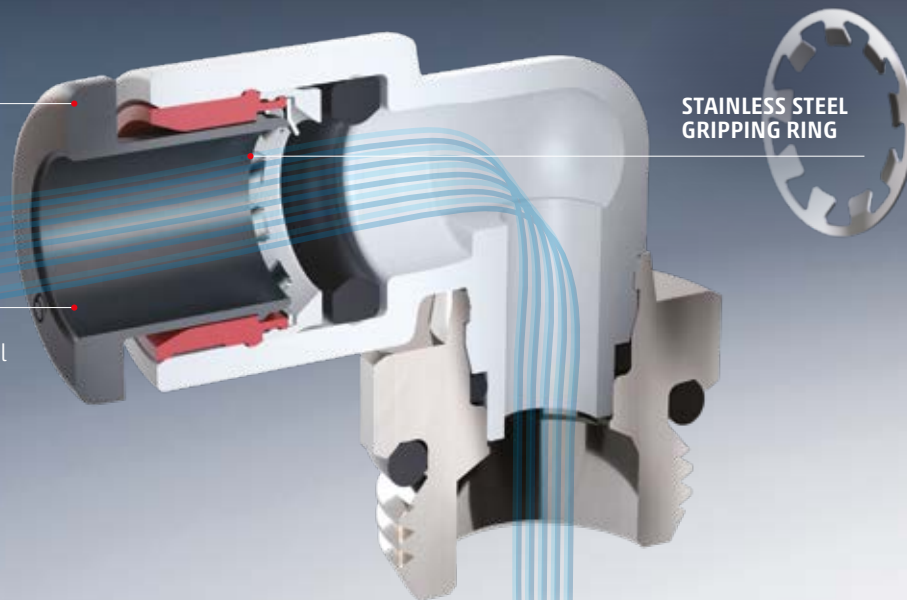

BENEFITS



Easy to connect and disconnect

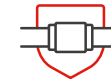

Optimum sealing



Long life cycle



High flow capacity



Limited marking on tubing



**PA11 BODY
Bio-sourced and reliable**

FIT FOR ANY APPLICATION

Series 7000 - Automation



MAIN TECHNICAL FEATURES

Diameters	4, 6, 8, 10, 12, 16 mm
Body	Technopolymer (PA66) Nickel-plated brass
Button	Technopolymer (PA66)
Gripping ring	Stainless steel (AISI 301)
Seal	NBR
Threads	Nickel-plated brass
Media	Compressed air and vacuum

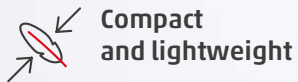
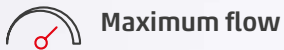
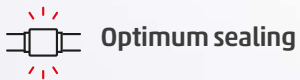

Series 7000 - Cooling



MAIN TECHNICAL FEATURES

Diameters	6, 8, 10, 12, 16 mm
Body	Technopolymer (PA11) Brass with chemical nickel plating
Button	Technopolymer (PA66)
Gripping ring	Stainless steel (AISI 301)
Seal	EPDM
Threads	Brass with chemical nickel plating
Media	Industrial water and cooling fluids

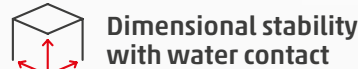

Series 7000 - Beverage and Water filtration



MAIN TECHNICAL FEATURES

Diameters	4, 6, 8 mm
Body	Technopolymer (PA11) Low lead brass (CW510L)
Button	Technopolymer (PA66)
Gripping ring	Stainless steel (AISI 301)
Seal	EPDM
Threads	Low lead brass (CW510L)
Media	Tap and drinking water, beverages and gases

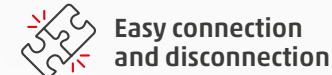
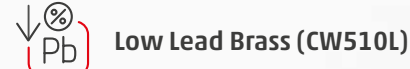

Series 7000 - Medical



MAIN TECHNICAL FEATURES

Diameters	4, 6, 8, 10 mm
Body	Technopolymer (PA11) Brass with chemical nickel plating
Button	Technopolymer (PA66)
Gripping ring	Stainless steel (AISI 301)
Seal	EPDM
Threads	Brass with chemical nickel plating
Media	Oxygen and medical gases

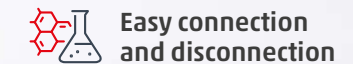
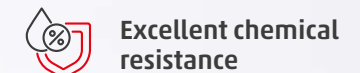
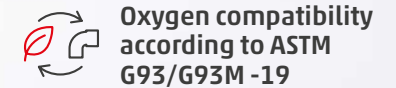

Contacts

Camozzi Automation S.p.A.

Società Unipersonale
Via Eritrea, 20/I
25126 Brescia
Italy
Tel. +39 030 37921
marketing@camozzi.com

Customer Service

Tel. +39 030 3792790
service@camozzi.com

Export Department

Tel. +39 030 3792253
sales@camozzi.com



Automation

Want to learn more?
Stay tuned with
Camozzi news

